

Three-pole Earthing and Short-circuiting Devices

SAFETY EQUIPMENT

EARTHING AND SHORT-CIRCUITING DEVICES

EN/IEC 61230 (DIN VDE 0683 Part 100)

Phase connecting components

Ball head cap, rigid, hexagon shaft



Fixed ball point Ø	Cable cross section	Max. short-circuit current I_k 1 s
20 mm	25/25 mm ²	4.9 kA
20 mm	35/35 mm ²	6.9 kA
20 mm	50/25 mm ²	9.9 kA
20 mm	70/35 mm ²	13.8 kA
20 mm	95/35 mm ²	18.7 kA
20 mm	120/50 mm ²	23.7 kA
25 mm	95/35 mm ²	18.7 kA
25 mm	120/50 mm ²	23.7 kA
25 mm	150/50 mm ²	29.6 kA

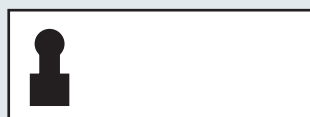

Fixed ball point Ø	Cable cross section	Max. short-circuit current I_k 1 s
20 mm	25/25 mm ²	4.9 kA
20 mm	35/35 mm ²	6.9 kA
20 mm	50/25 mm ²	9.9 kA
20 mm	70/35 mm ²	13.8 kA
20 mm	95/35 mm ²	18.7 kA
20 mm	120/50 mm ²	23.7 kA
25 mm	95/35 mm ²	18.7 kA
25 mm	120/50 mm ²	23.7 kA
25 mm	150/50 mm ²	29.6 kA



Fixed ball point Ø	Cable cross section	Max. short-circuit current I_k 1 s
20 mm	25/25 mm ²	4.9 kA
20 mm	35/35 mm ²	6.9 kA
20 mm	50/25 mm ²	9.9 kA
20 mm	70/35 mm ²	13.8 kA
20 mm	95/35 mm ²	18.7 kA
20 mm	120/50 mm ²	23.7 kA
25 mm	95/35 mm ²	18.7 kA
25 mm	120/50 mm ²	23.7 kA
25 mm	150/50 mm ²	29.6 kA

Earth connecting components



M12

775 621



M12x15

775 626



790 150

Part No.	Part No.	Part No.
725 618	725 317	725 358
735 618	735 317	735 358
750 350	750 317	750 358
770 350	770 317	770 358
794 350	794 317	794 358
711 350	711 317	711 358
795 350	795 317	795 358
712 350	712 317	712 358
715 350	715 317	715 358



M16

775 631



M16x15

775 636



792 030

Part No.	Part No.	Part No.
725 362	725 363	725 360
735 362	735 363	735 360
750 362	750 363	750 360
770 362	770 363	770 360
794 362	794 363	794 360
711 362	711 363	711 360
795 362	795 363	795 360
712 362	712 363	712 360
715 362	715 363	715 360



772 312/772 322



772 313/772 323



774 030/774 130

Part No.	Part No.	Part No.
725 619	725 357	725 359
735 619	735 357	735 359
750 356	750 357	750 359
770 356	770 357	770 359
794 356	794 357	794 359
711 356	711 357	711 359
795 356	795 357	795 359
712 356	712 357	712 359
715 356	715 357	715 359

Other cable lengths as well as types with unreduced earthing cable cross sections, other earthing clamps and earth connection units available on request. Earthing rod not included in delivery.

SAFETY EQUIPMENT

Three-pole Earthing and Short-Circuiting Devices

EARTHING AND SHORT-CIRCUITING DEVICES

EN/IEC 61230 (DIN VDE 0683 Part 100)

Phase connecting components

Ball head cap, rigid,
T pin shaft

775 621

775 626

790 150

Fixed ball point Ø	Cable cross section	Max. short-circuit current I_k 1 s	Part No.	Part No.	Part No.
20 mm	25/25 mm ²	4.9 kA	725 620	725 365	725 368
20 mm	35/35 mm ²	6.9 kA	735 620	735 365	735 368
20 mm	50/25 mm ²	9.9 kA	750 351	750 365	750 368
20 mm	70/35 mm ²	13.8 kA	770 351	770 365	770 368
20 mm	95/35 mm ²	18.7 kA	794 351	794 365	794 368
20 mm	120/50 mm ²	23.7 kA	711 351	711 365	711 368
25 mm	95/35 mm ²	18.7 kA	795 351	795 365	795 368
25 mm	120/50 mm ²	23.7 kA	712 351	712 365	712 368
25 mm	150/50 mm ²	29.6 kA	715 351	715 365	715 368

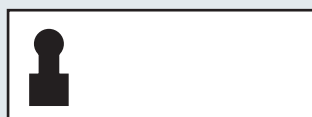

775 631

775 636

792 030

Fixed ball point Ø	Cable cross section	Max. short-circuit current I_k 1 s	Part No.	Part No.	Part No.
20 mm	25/25 mm ²	4.9 kA	725 372	725 373	725 370
20 mm	35/35 mm ²	6.9 kA	735 372	735 373	735 370
20 mm	50/25 mm ²	9.9 kA	750 372	750 373	750 370
20 mm	70/35 mm ²	13.8 kA	770 372	770 373	770 370
20 mm	95/35 mm ²	18.7 kA	794 372	794 373	794 370
20 mm	120/50 mm ²	23.7 kA	711 372	711 373	711 370
25 mm	95/35 mm ²	18.7 kA	795 372	795 373	795 370
25 mm	120/50 mm ²	23.7 kA	712 372	712 373	712 370
25 mm	150/50 mm ²	29.6 kA	715 372	715 373	715 370



772 312/772 322

772 313/772 323

774 030/774 130

Fixed ball point Ø	Cable cross section	Max. short-circuit current I_k 1 s	Part No.	Part No.	Part No.
20 mm	25/25 mm ²	4.9 kA	725 621	725 367	725 369
20 mm	35/35 mm ²	6.9 kA	735 621	735 367	735 369
20 mm	50/25 mm ²	9.9 kA	750 366	750 367	750 369
20 mm	70/35 mm ²	13.8 kA	770 366	770 367	770 369
20 mm	95/35 mm ²	18.7 kA	794 366	794 367	794 369
20 mm	120/50 mm ²	23.7 kA	711 366	711 367	711 369
25 mm	95/35 mm ²	18.7 kA	795 366	795 367	795 369
25 mm	120/50 mm ²	23.7 kA	712 366	712 367	712 369
25 mm	150/50 mm ²	29.6 kA	715 366	715 367	715 369

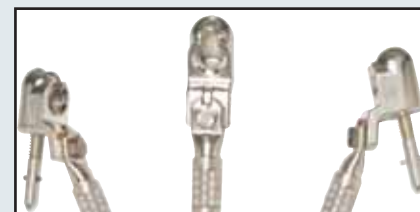

a b c = 600 mm

d = 1800 mm



Other cable lengths as well as types with unreduced earthing cable cross sections, other earthing clamps and earth connection units available on request. Earthing rod not included in delivery.

Three-pole Earthing and Short-circuiting Devices

SAFETY EQUIPMENT

EARTHING AND SHORT-CIRCUITING DEVICES

IEC/EN 61230 (DIN VDE 0683 Part 100)

Phase connecting components

**Ball head cap,
adjustable (4 x 90°),
hexagon shaft**

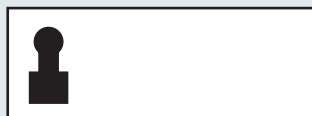
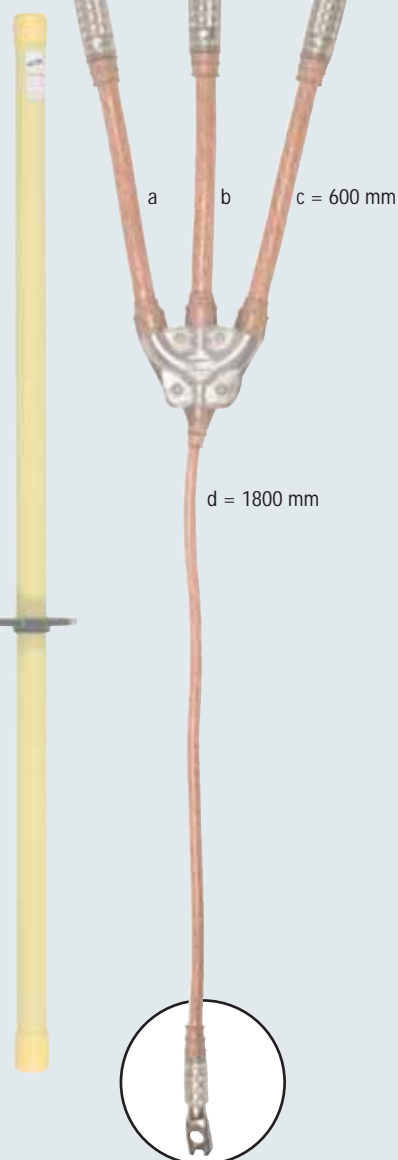
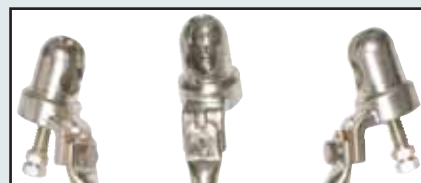

Fixed ball point Ø	Cable cross section	Max. short-circuit current I_k 1 s
20 mm	25/25 mm ²	4.9 kA
20 mm	35/35 mm ²	6.9 kA
20 mm	50/25 mm ²	9.9 kA
20 mm	70/35 mm ²	13.8 kA
20 mm	95/35 mm ²	18.7 kA
20 mm	120/50 mm ²	23.7 kA
25 mm	95/35 mm ²	18.7 kA
25 mm	120/50 mm ²	23.7 kA
25 mm	150/50 mm ²	29.6 kA



Fixed ball point Ø	Cable cross section	Max. short-circuit current I_k 1 s
20 mm	25/25 mm ²	4.9 kA
20 mm	35/35 mm ²	6.9 kA
20 mm	50/25 mm ²	9.9 kA
20 mm	70/35 mm ²	13.8 kA
20 mm	95/35 mm ²	18.7 kA
20 mm	120/50 mm ²	23.7 kA
25 mm	95/35 mm ²	18.7 kA
25 mm	120/50 mm ²	23.7 kA
25 mm	150/50 mm ²	29.6 kA

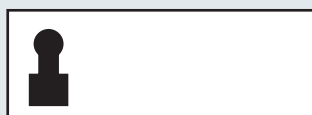

Fixed ball point Ø	Cable cross section	Max. short-circuit current I_k 1 s
20 mm	25/25 mm ²	4.9 kA
20 mm	35/35 mm ²	6.9 kA
20 mm	50/25 mm ²	9.9 kA
20 mm	70/35 mm ²	13.8 kA
20 mm	95/35 mm ²	18.7 kA
20 mm	120/50 mm ²	23.7 kA
25 mm	95/35 mm ²	18.7 kA
25 mm	120/50 mm ²	23.7 kA
25 mm	150/50 mm ²	29.6 kA

Earth connecting components

M12
775 621M12x15
775 626

790 150

Part No.
725 718
735 718
750 353
770 353
794 353
711 353
795 374
712 374
715 374

Part No.
725 375
735 375
750 375
770 375
794 375
711 375
795 375
712 375
715 375

Part No.
725 378
735 378
750 378
770 378
794 378
711 378
795 378
712 378
715 378

M16
775 631M16x15
775 636

792 030

Part No.
725 382
735 382
750 382
770 382
794 382
711 382
795 382
712 382
715 382

Part No.
725 383
735 383
750 383
770 383
794 383
711 383
795 383
712 383
715 383

Part No.
725 380
735 380
750 380
770 380
794 380
711 380
795 380
712 380
715 380



772 312/772 322



772 313/772 323



774 030/774 130

Part No.
725 719
735 719
750 376
770 376
794 376
711 376
795 376
712 376
715 376

Part No.
725 377
735 377
750 377
770 377
794 377
711 377
795 950
712 950
715 950

Part No.
725 379
735 379
750 379
770 379
794 379
711 379
795 379
712 379
715 379

Other cable lengths as well as types with unreduced earthing cable cross sections, other earthing clamps and earth connection units available on request. Earthing rod not included in delivery.

SAFETY EQUIPMENT

Three-pole Earthing and Short-circuiting Devices

EARTHING AND SHORT-CIRCUITING DEVICES

IEC/EN 61230 (DIN VDE 0683 Part 100)

Phase connecting components

Earth connecting components



**Ball head cap,
adjustable (4 x 90°),
T pin shaft**

Fixed ball point Ø	Cable cross section	Max. short-circuit current I_k 1 s	Part No.	Part No.	Part No.
20 mm	25/25 mm ²	4.9 kA	725 720	725 385	725 388
20 mm	35/35 mm ²	6.9 kA	735 720	735 385	735 388
20 mm	50/25 mm ²	9.9 kA	750 354	750 385	750 388
20 mm	70/35 mm ²	13.8 kA	770 354	770 385	770 388
20 mm	95/35 mm ²	18.7 kA	794 354	794 385	794 388
20 mm	120/50 mm ²	23.7 kA	711 354	711 385	711 388
25 mm	95/35 mm ²	18.7 kA	795 384	795 385	795 388
25 mm	120/50 mm ²	23.7 kA	712 384	712 385	712 388
25 mm	150/50 mm ²	29.6 kA	715 384	715 385	715 388

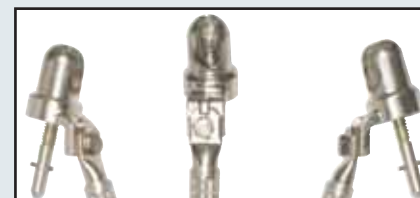

Fixed ball point Ø	Cable cross section	Max. short-circuit current I_k 1 s	Part No.	Part No.	Part No.
20 mm	25/25 mm ²	4.9 kA	725 392	725 393	725 390
20 mm	35/35 mm ²	6.9 kA	735 392	735 393	735 390
20 mm	50/25 mm ²	9.9 kA	750 392	750 393	750 390
20 mm	70/35 mm ²	13.8 kA	770 392	770 393	770 390
20 mm	95/35 mm ²	18.7 kA	794 392	794 393	794 390
20 mm	120/50 mm ²	23.7 kA	711 392	711 393	711 390
25 mm	95/35 mm ²	18.7 kA	795 392	795 393	795 390
25 mm	120/50 mm ²	23.7 kA	712 392	712 393	712 390
25 mm	150/50 mm ²	29.6 kA	715 392	715 393	715 390



Fixed ball point Ø	Cable cross section	Max. short-circuit current I_k 1 s	Part No.	Part No.	Part No.
20 mm	25/25 mm ²	4.9 kA	725 721	725 387	725 389
20 mm	35/35 mm ²	6.9 kA	735 721	735 387	735 389
20 mm	50/25 mm ²	9.9 kA	750 386	750 387	750 389
20 mm	70/35 mm ²	13.8 kA	770 386	770 387	770 389
20 mm	95/35 mm ²	18.7 kA	794 386	794 387	794 389
20 mm	120/50 mm ²	23.7 kA	711 386	711 387	711 389
25 mm	95/35 mm ²	18.7 kA	795 386	795 951	795 389
25 mm	120/50 mm ²	23.7 kA	712 386	712 951	712 389
25 mm	150/50 mm ²	29.6 kA	715 386	715 951	715 389

Other cable lengths as well as types with unreduced earthing cable cross sections, other earthing clamps and earth connection units available on request. Earthing rod not included in delivery.

Three-pole Earthing and Short-circuiting Devices

SAFETY EQUIPMENT

EARTHING AND SHORT-CIRCUITING DEVICES

IEC/EN 61230 (DIN VDE 0683 Part 100)

Phase connecting components

Universal clamp, clamping range 20 mm, hexagon shaft



Earth connecting components



M12

775 621



790 150

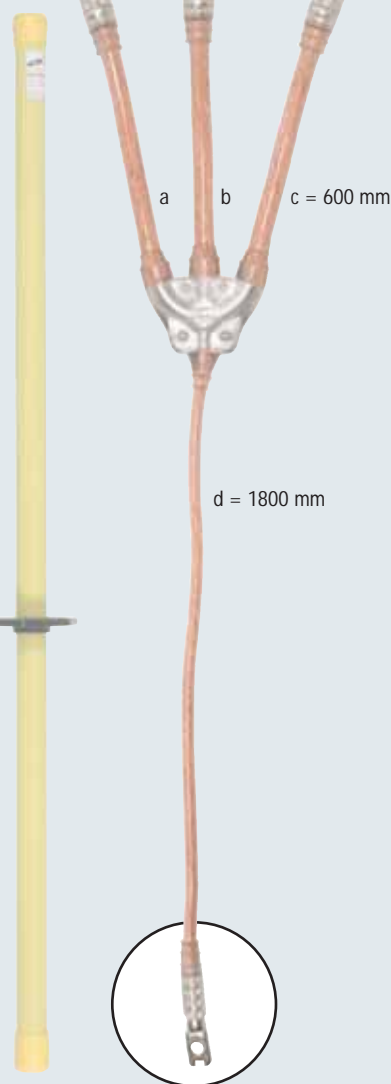

Fixed ball point Ø	Phase T pin Collar width	Rd / FI Clamping range	Cable cross section	Max. short-circuit current I_k 1 s
20 mm	11 mm	20 mm	25/25 mm ²	4.9 kA
20 mm	11 mm	20 mm	35/35 mm ²	6.9 kA
20 mm	11 mm	20 mm	50/25 mm ²	9.9 kA
20 mm	11 mm	20 mm	70/35 mm ²	13.8 kA
20 mm	11 mm	— mm	95/35 mm ²	18.7 kA
20 mm	— mm	— mm	120/50 mm ²	23.7 kA

Part No.	Part No.
725 823	725 826
735 823	735 826
750 823	750 826
770 823	770 826
795 823	795 826
712 823	712 826



774 030



792 030

Fixed ball point Ø	Phase T pin Collar width	Rd / FI Clamping range	Cable cross section	Max. short-circuit current I_k 1 s
20 mm	11 mm	20 mm	25/25 mm ²	4.9 kA
20 mm	11 mm	20 mm	35/35 mm ²	6.9 kA
20 mm	11 mm	20 mm	50/25 mm ²	9.9 kA
20 mm	11 mm	20 mm	70/35 mm ²	13.8 kA
20 mm	11 mm	— mm	95/35 mm ²	18.7 kA
20 mm	— mm	— mm	120/50 mm ²	23.7 kA

Part No.	Part No.
725 822	725 821
735 822	735 821
750 822	750 821
770 822	770 821
795 822	795 821
712 822	712 821



774 230

Fixed ball point Ø	Phase T pin Collar width	Rd / FI Clamping range	Cable cross section	Max. short-circuit current I_k 1 s
20 mm	11 mm	20 mm	25/25 mm ²	4.9 kA
20 mm	11 mm	20 mm	35/35 mm ²	6.9 kA
20 mm	11 mm	20 mm	50/25 mm ²	9.9 kA
20 mm	11 mm	20 mm	70/35 mm ²	13.8 kA
20 mm	11 mm	— mm	95/35 mm ²	18.7 kA
20 mm	— mm	— mm	120/50 mm ²	23.7 kA

Part No.
725 825
735 825
750 825
770 825
795 825
712 825

Other cable lengths as well as types with unreduced earthing cable cross sections, other earthing clamps and earth connection units available on request. Earthing rod not included in delivery.

SAFETY EQUIPMENT

Three-pole Earthing and Short-circuiting Devices

EARTHING AND SHORT-CIRCUITING DEVICES

IEC/EN 61230 (DIN VDE 0683 Part 100)

Earth connecting components

Phase connecting components



775 621



790 150

Universal clamp, clamping range 20 mm, T pin shaft

Fixed ball point Ø	Phase T pin Collar width	Rd / FI Clamping range	Cable cross section	Max. short-circuit current I_k 1 s
20 mm	11 mm	20 mm	25/25 mm ²	4.9 kA
20 mm	11 mm	20 mm	35/35 mm ²	6.9 kA
20 mm	11 mm	20 mm	50/25 mm ²	9.9 kA
20 mm	11 mm	20 mm	70/35 mm ²	13.8 kA
20 mm	11 mm	— mm	95/35 mm ²	18.7 kA
20 mm	— mm	— mm	120/50 mm ²	23.7 kA

Part No.
725 833
735 833
750 833
770 833
795 833
712 833

Part No.
725 836
735 836
750 836
770 836
795 836
712 836



774 030



792 030

Fixed ball point Ø	Phase T pin Collar width	Rd / FI Clamping range	Cable cross section	Max. short-circuit current I_k 1 s
20 mm	11 mm	20 mm	25/25 mm ²	4.9 kA
20 mm	11 mm	20 mm	35/35 mm ²	6.9 kA
20 mm	11 mm	20 mm	50/25 mm ²	9.9 kA
20 mm	11 mm	20 mm	70/35 mm ²	13.8 kA
20 mm	11 mm	— mm	95/35 mm ²	18.7 kA
20 mm	— mm	— mm	120/50 mm ²	23.7 kA

Part No.
725 832
735 832
750 832
770 832
795 832
712 832

Part No.
725 831
735 831
750 831
770 831
795 831
712 831



774 230

Fixed ball point Ø	Phase T pin Collar width	Rd / FI Clamping range	Cable cross section	Max. short-circuit current I_k 1 s
20 mm	11 mm	20 mm	25/25 mm ²	4.9 kA
20 mm	11 mm	20 mm	35/35 mm ²	6.9 kA
20 mm	11 mm	20 mm	50/25 mm ²	9.9 kA
20 mm	11 mm	20 mm	70/35 mm ²	13.8 kA
20 mm	11 mm	— mm	95/35 mm ²	18.7 kA
20 mm	— mm	— mm	120/50 mm ²	23.7 kA

Part No.
725 835
735 835
750 835
770 835
795 835
712 835

Other cable lengths as well as types with unreduced earthing cable cross sections, other earthing clamps and earth connection units available on request.
Earthing rod not included in delivery.

Three-pole Earthing and Short-circuiting Devices

SAFETY EQUIPMENT

EARTHING AND SHORT-CIRCUITING DEVICES

IEC/EN 61230 (DIN VDE 0683 Part 100)

Phase connecting components

Universal clamp, clamping range 30 mm, hexagon shaft



Fixed ball point Ø	Phase T pin Collar width	Rd / FI Clamping range	Cable cross section	Max. short-circuit current I_k 1 s	Part No.	Part No.
25 / 30 mm	18 mm	30 mm	25/25 mm ²	4.9 kA	725 804	725 807
25 / 30 mm	18 mm	30 mm	35/35 mm ²	6.9 kA	735 804	735 807
25 / 30 mm	18 mm	30 mm	50/25 mm ²	9.9 kA	750 804	750 807
25 / 30 mm	18 mm	30 mm	70/35 mm ²	13.8 kA	770 804	770 807
25 / 30 mm	18 mm	— mm	95/35 mm ²	18.7 kA	795 804	795 807
25 / 30 mm	— mm	— mm	120/50 mm ²	23.7 kA	712 804	712 807

Earth connecting components



M12

775 621



790 150

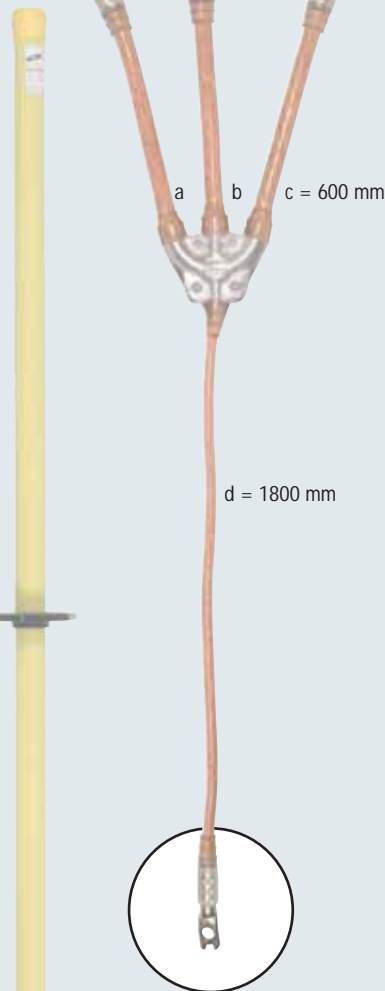

Fixed ball point Ø	Phase T pin Collar width	Rd / FI Clamping range	Cable cross section	Max. short-circuit current I_k 1 s	Part No.	Part No.
25 / 30 mm	18 mm	30 mm	25/25 mm ²	4.9 kA	725 115	725 802
25 / 30 mm	18 mm	30 mm	35/35 mm ²	6.9 kA	735 115	735 802
25 / 30 mm	18 mm	30 mm	50/25 mm ²	9.9 kA	750 803	750 802
25 / 30 mm	18 mm	30 mm	70/35 mm ²	13.8 kA	770 803	770 802
25 / 30 mm	18 mm	— mm	95/35 mm ²	18.7 kA	795 803	795 802
25 / 30 mm	— mm	— mm	120/50 mm ²	23.7 kA	712 803	712 802



774 130



792 030



Fixed ball point Ø	Phase T pin Collar width	Rd / FI Clamping range	Cable cross section	Max. short-circuit current I_k 1 s	Part No.
25 / 30 mm	18 mm	30 mm	25/25 mm ²	4.9 kA	725 806
25 / 30 mm	18 mm	30 mm	35/35 mm ²	6.9 kA	735 806
25 / 30 mm	18 mm	30 mm	50/25 mm ²	9.9 kA	750 806
25 / 30 mm	18 mm	30 mm	70/35 mm ²	13.8 kA	770 806
25 / 30 mm	18 mm	— mm	95/35 mm ²	18.7 kA	795 806
25 / 30 mm	— mm	— mm	120/50 mm ²	23.7 kA	712 806



774 330

Other cable lengths as well as types with unreduced earthing cable cross sections, other earthing clamps and earth connection units available on request.
Earthing rod not included in delivery.

SAFETY EQUIPMENT

Three-pole Earthing and Short-circuiting Devices

EARTHING AND SHORT-CIRCUITING DEVICES

IEC/EN 61230 (DIN VDE 0683 Part 100)

Earth connecting components

Phase connecting components



M12

775 621



790 150

Universal clamp, clamping range 30 mm, T pin shaft

Fixed ball point Ø	Phase T pin Collar width	Rd / FI Clamping range	Cable cross section	Max. short-circuit current I_k 1 s
25 / 30 mm	18 mm	30 mm	25/25 mm ²	4.9 kA
25 / 30 mm	18 mm	30 mm	35/35 mm ²	6.9 kA
25 / 30 mm	18 mm	30 mm	50/25 mm ²	9.9 kA
25 / 30 mm	18 mm	30 mm	70/35 mm ²	13.8 kA
25 / 30 mm	18 mm	— mm	95/35 mm ²	18.7 kA
25 / 30 mm	— mm	— mm	120/50 mm ²	23.7 kA

Part No.
725 813
735 813
750 813
770 813
795 813
712 813

Part No.
725 816
735 816
750 816
770 816
795 816
712 816

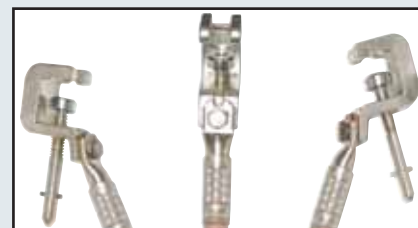

774 130



792 030

Fixed ball point Ø	Phase T pin Collar width	Rd / FI Clamping range	Cable cross section	Max. short-circuit current I_k 1 s
25 / 30 mm	18 mm	30 mm	25/25 mm ²	4.9 kA
25 / 30 mm	18 mm	30 mm	35/35 mm ²	6.9 kA
25 / 30 mm	18 mm	30 mm	50/25 mm ²	9.9 kA
25 / 30 mm	18 mm	30 mm	70/35 mm ²	13.8 kA
25 / 30 mm	18 mm	— mm	95/35 mm ²	18.7 kA
25 / 30 mm	— mm	— mm	120/50 mm ²	23.7 kA

Part No.
725 117
735 117
750 812
770 812
795 812
712 812

Part No.
725 811
735 811
750 811
770 811
795 811
712 811

a b c = 600 mm

d = 1800 mm



774 330

Fixed ball point Ø	Phase T pin Collar width	Rd / FI Clamping range	Cable cross section	Max. short-circuit current I_k 1 s
25 / 30 mm	18 mm	30 mm	25/25 mm ²	4.9 kA
25 / 30 mm	18 mm	30 mm	35/35 mm ²	6.9 kA
25 / 30 mm	18 mm	30 mm	50/25 mm ²	9.9 kA
25 / 30 mm	18 mm	30 mm	70/35 mm ²	13.8 kA
25 / 30 mm	18 mm	— mm	95/35 mm ²	18.7 kA
25 / 30 mm	— mm	— mm	120/50 mm ²	23.7 kA

Part No.
725 815
735 815
750 815
770 815
795 815
712 815



Other cable lengths as well as types with unreduced earthing cable cross sections, other earthing clamps and earth connection units available on request.
Earthing rod not included in delivery.

Three-pole Earthing and Short-circuiting Devices

SAFETY EQUIPMENT

Short-circuiting bar

EARTHING AND SHORT-CIRCUITING DEVICES

EN/IEC 61230 (DIN VDE 0683 Part 100)

- With longitudinal slot for reliable contact
- For Cu or Al busbars, up to 25 mm thick
- Other bars and earthing cable lengths available on request
- Operation with earthing rod, shaft type with hexagon terminal or T pin shaft



Short-circuiting bar with earthing cable in use at a switchgear.

The short-circuiting bar with longitudinal slot can be used for installations with compensated systems.

The earthing cable is supplied with a ball head cap with wing nut for fixed ball points Ø20 mm for connection to the earthing system (other types of equipment available on request).

The short-circuiting bars can be provided with 2 different coupling devices used with earthing rods:

Technical Data

Earthing cable	Cu, highly flexible
Cable cross section	50 mm ²
Cable length	2500 mm
Operating temperature range	-25° C ... +55° C

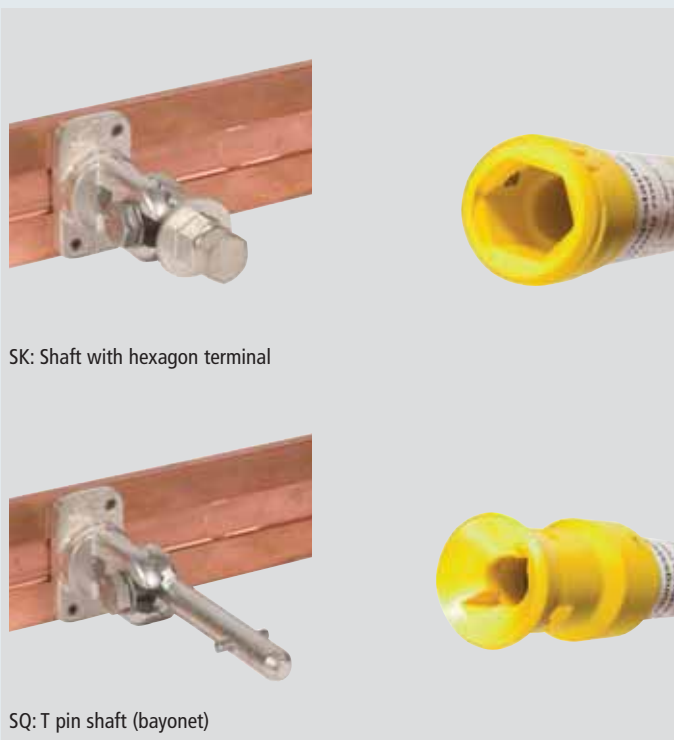

SK: Shaft with hexagon terminal

SQ: T pin shaft (bayonet)

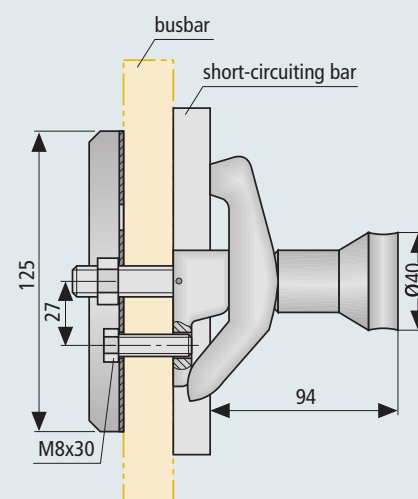

SK: Shaft with hexagon terminal

SAFETY EQUIPMENT

Three-pole Earthing and Short-circuiting Devices

EARTHING AND SHORT-CIRCUITING DEVICES

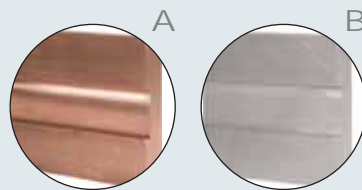

Type	Coupling device	Profile h x w	Total length l_G	Max. short-circuit current I_k 1 s	Part No.
------	-----------------	---------------	--------------------	--------------------------------------	----------

A Short-circuiting bar made of E-Cu F20

KSS 60 8 CU SK	SK	60 x 8 mm	520 mm	70.0 kA	795 038
KSS 60 12 CU SK	SK	60 x 12 mm	520 mm	90.0 kA	795 039
KSS 60 8 CU SQ	SQ	60 x 8 mm	520 mm	70.0 kA	795 041
KSS 60 12 CU SQ	SQ	60 x 12 mm	520 mm	90.0 kA	795 045

B Short-circuiting bar made of AlMgSi 0.5

KSS 60 8 AL SK	SK	60 x 8 mm	520 mm	45.0 kA	795 042
KSS 60 12 AL SK	SK	60 x 12 mm	520 mm	70.0 kA	795 043
KSS 60 8 AL SQ	SQ	60 x 8 mm	520 mm	45.0 kA	795 048
KSS 60 12 AL SQ	SQ	60 x 12 mm	520 mm	70.0 kA	795 049

Note: When placing your order, please confirm the bar distance (S_A) and the bar width (S_B) required.

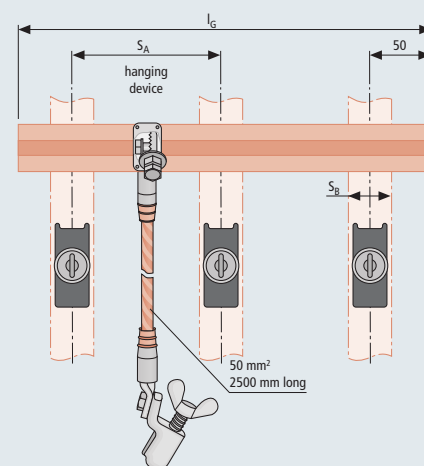
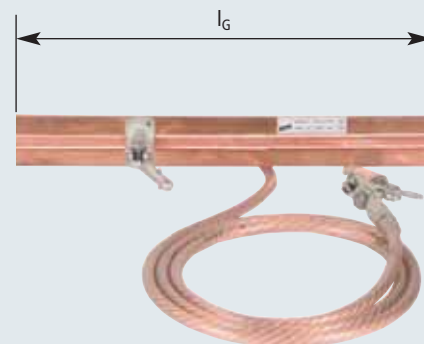

Accessories for Three-pole Earthing and Short-circuiting Devices

Fixed clamping points for busbars

With eye and contact claw

Type	Part No.
KLFP M12 KSS	795 040

**SK Screw adapter**

Hexagon terminal, width across: SW 19

Type	Total length l_G	Part No.
SA KLFP SK	60 mm	795 214

**SQ Screw adapter**

T pin shaft (bayonet)

Type	Total length l_G	Part No.
SA KLFP SQ	100 mm	795 213

